

5.0GXIE-270-R

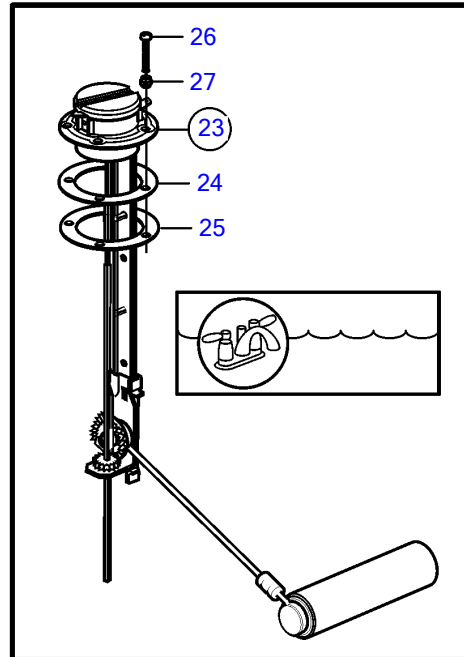
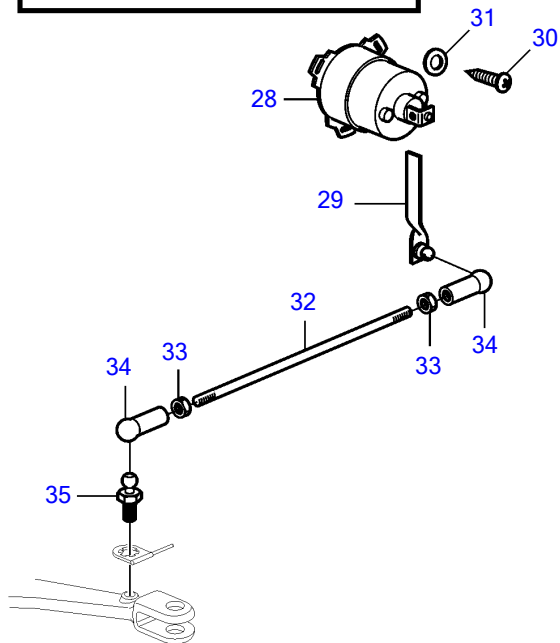
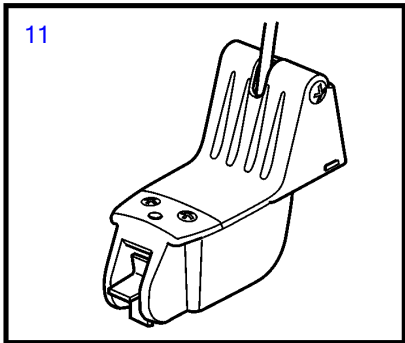
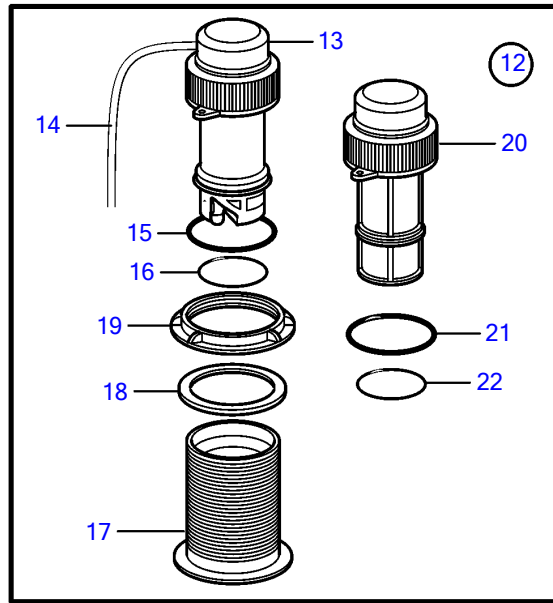
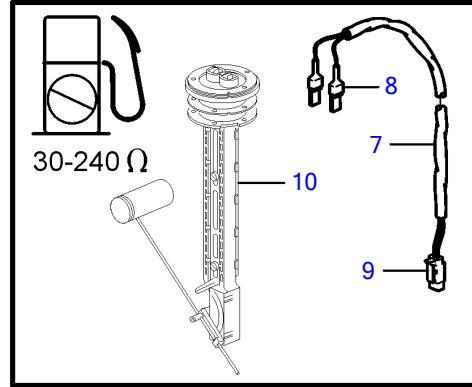
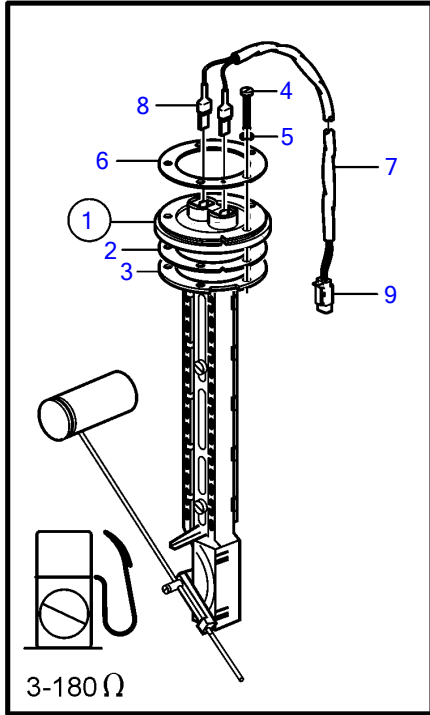

24017

5.0GXIE-270-R

REF	PART NO.	QTY	DESCRIPTION	NOTES
1	873772	1	Tank sensor	3-180 Ohms
2	89865	1	• Gasket	
3	834480	1	• Flange	
4	969408	4	• 6 point socket screw	L=20mm
		1	• Screw	L=30mm
5	834481	5	• Gasket	
6		1	• Flange	not sold separately
7		1	Wires	part not sold
		1	Cover	
8	949210	2	Cable terminal	
	949597	2	Housing	
9		1	Housing	FCI 54200210
		2	Terminal	FCI 54001801
10		1	Sender, fuel level	30-240 Ohms, Not supplied by Volvo Penta
11	3587055	1	Sensor, multi-sensor	Mounted on transom
12	3587054	1	Sensor, multi-sensor	Through hull
13		1	• Sender	not sold separately
14		1	• Cable	not sold separately
15		1	• O-ring	not sold separately
16		1	• O-ring	not sold separately
17		1	• Fitting, through hull	not sold separately
18		1	• Seal	not sold separately
19		1	• Nut	not sold separately
20		1	• Plug	not sold separately
21		1	• O-ring	not sold separately
22		1	• O-ring	not sold separately
23	834389	1	Tank sensor, water level	
24	89865	1	• Gasket	
25	834480	1	• Flange	
26	969407	4	• 6 point socket screw	L=16mm
		1	• Screw	L=30mm
27	834481	5	• Gasket	
28	837772	1	Position sensor, drive	
29	3863388	1	Arm	
30	955132	3	Cross recessed screw	
31	955891	3	Washer	
32	943549	1	Control rod	
33	942836	1	Hexagon nut	Left hand threads
	955780	1	Hexagon nut	Right hand threads
34	946704	1	Ball socket	Left hand threads
	946703	1	Ball socket	Right hand threads
35	21319346	1	Ball stud	